

30+ YEARS OF WIPRO LIGHTING



GLEAMLINE

THE HIDDEN BRILLIANCE

wipro advantage



www.wiprolighting.com | Toll free no: 1800 425 1969 | helpdesk.lighting@wipro.com

Registered Office: Wipro Enterprises (P) Ltd.
'Wipro House', No. 8, 7th Main, 80 Feet Road,
Koramangala, 1st Block, Bangalore 560034

Business Office: Wipro Lighting,
5th Floor, Godrej Eternia-C, Old Pune-Mumbai
Highway, Shivajinagar, Pune 411005
(T) 020 66098700, (F) 020 66098777



Branches: Ahmedabad | Bangalore | Bhubaneshwar | Chandigarh | Chennai | Cochin | Coimbatore | Hyderabad | Indore | Jaipur | Kolkata | Lucknow | Mumbai | Nagpur | New Delhi | Pune | Raipur | Vishakhapatnam



Innovation and improvement are a way of life at Wipro. All rights reserved. Reproduction of this data in parts or in whole, without permission, is prohibited. Care has been taken to ensure that the information content within is correct. We reserve the right to modify the product without prior intimation. Imitation of Registered Designs is a punishable offence. | Follow us on

Beyond what meets the eye. The best things always remain hidden.

Gleamline is an experience like no other. It is what lighting designers mean when they say human-centric in all the way it can be. It is the perfect example of how design excellence meet optical efficiency, all hidden at plain sight, housed in a marvelously sleek, contemporary luminaire.



Shadow-free illumination



Comfort for your eyes



Stable and flicker-free



Uniform light distribution



Innovative design



Future ready





India's first indirect linear with the best modeling ratio

In this modern era, where virtual meetings are prevalent, luminaires are no longer to just light up the surface and its surrounding area. Illumination of the person's face is also equally essential. Lighting should be uniformly designed wherein no under-eye darkness or vertical shadows are visible during video conferences.

Gleamline creates a proper ratio of vertical and horizontal illumination. Up to 12% increase in vertical illumination level and up to 20% increase in vertical illuminance uniformity than the other standard linear distribution.

Volumetric soft lighting creates a better face profile



Incorrect Lighting Volumetric Soft Lighting Incorrect Lighting

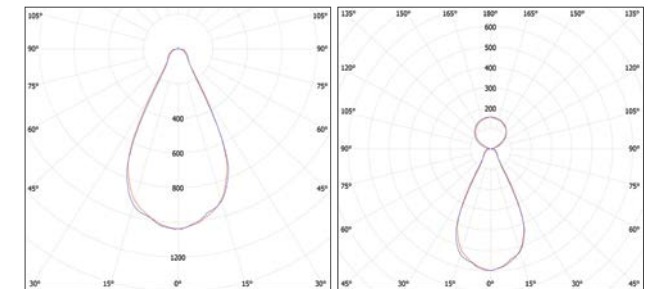

- Maximum candela: 967.1 cd
- Beam efficiency: 77%
- Field efficiency: 98%
- UGR<19
- Beam angle: 60°



DESIGN REGISTERED

Multitude of ideas, harmoniously housed.

Gleamline is made to open up the limits of imagination. With its different optical combinations, Gleamline lights up a space the way it's meant to be. Be it a calm and relaxed ambience, or a highly productive task beam, Gleamline effortlessly provides you with an apt lighting configuration.

Direct / Indirect with Collimator

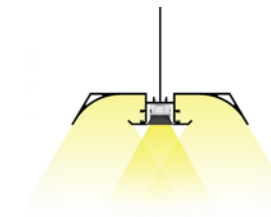

100% Downlight

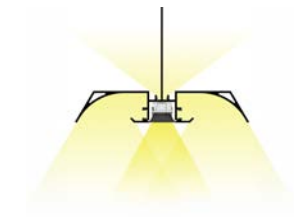

Downlight + Up-light

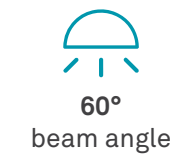

60°
beam angle



UGR<19
for Down



UGR<16
for Up-Down



CRI 90

Slim and wide, distinctively designed

Gleamline's unique design draws a visual contrast of large wings accommodated in a slim, sleek luminaire. The large wings housing the light engine provides a wide light output while keeping the luminaire weight low. Its innovative design hides the light source, ensuring a shadowless light window and a uniform light gradient on the wings.

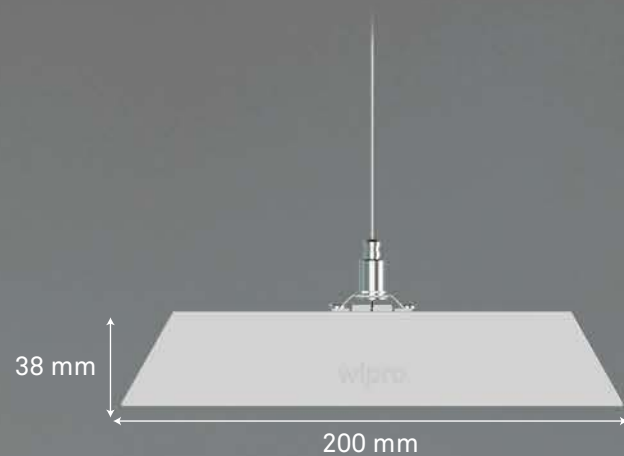

Available in standard length of 4 & 8 feet.

Suitable for:



Video Conferencing



Meeting Rooms



Refurbish Applications



Studios



Boardrooms

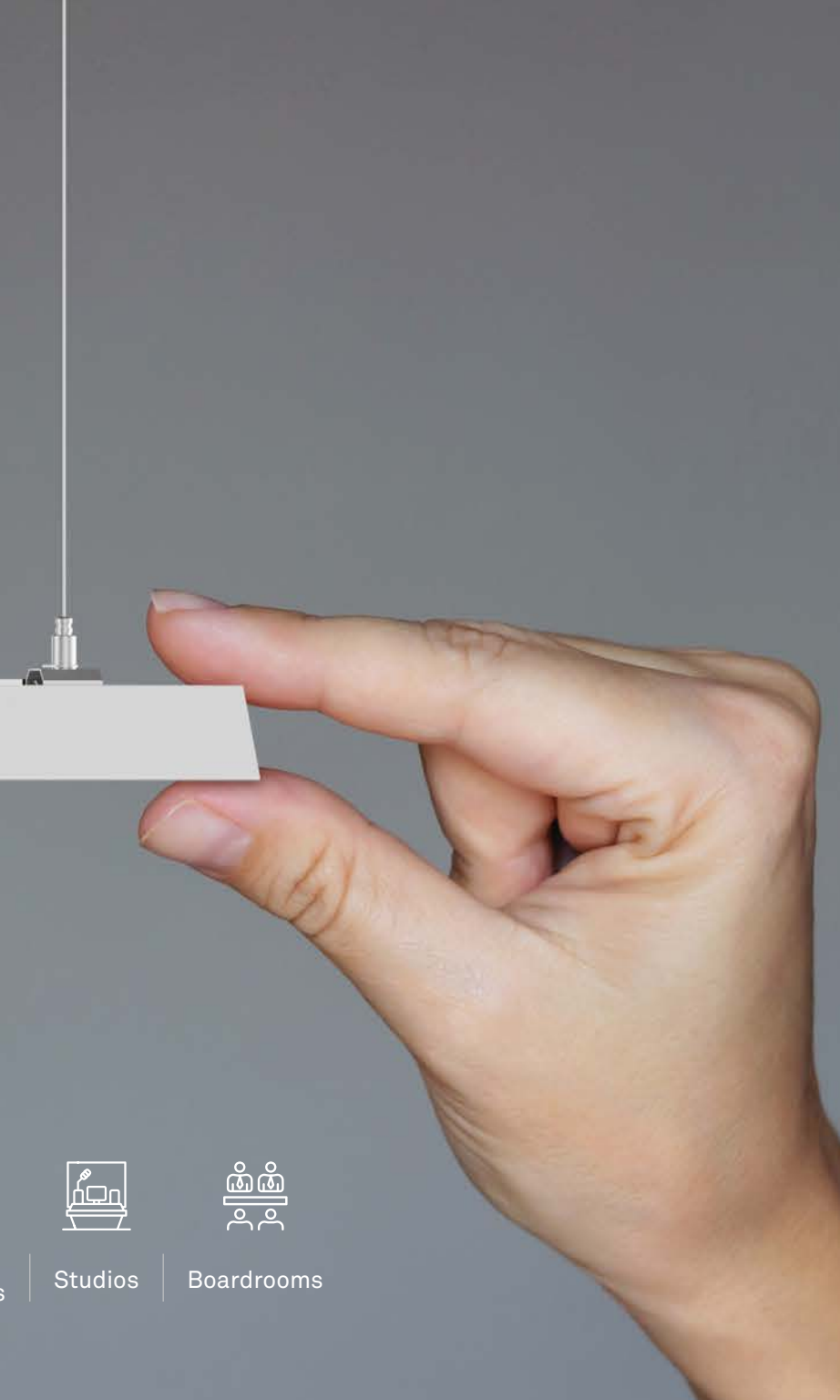

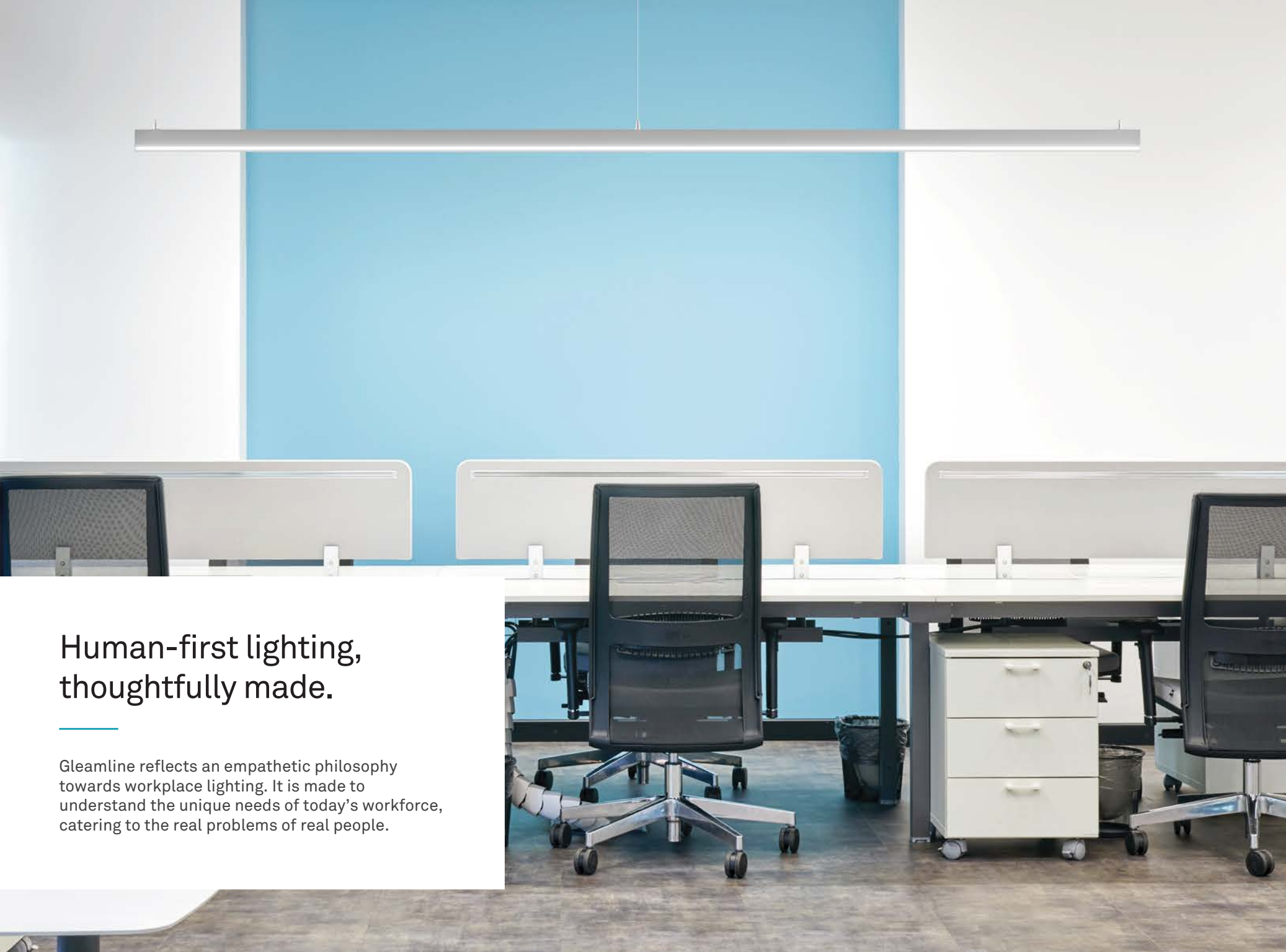

Human-first lighting, thoughtfully made.

Gleamline reflects an empathetic philosophy towards workplace lighting. It is made to understand the unique needs of today's workforce, catering to the real problems of real people.

Shadow-free and well-lit

Gleamline's indirect mode of lighting minimizes glare and harsh shadows, providing an efficient, work-positive environment

Stable and flicker-free

Gleamline eliminates eye strain due to its consistent and stable light output, making it especially useful during video conferences

Uniform and balanced

Gleamline's excellent modelling ratio and high light uniformity on horizontal and vertical planes enhances the depth and detail of the illuminated area

Calm and relaxed

Gleamline's soft and soothing light output is gentle on the eyes, making it ideal for environments where people spend extended time

Compatible Wipro platforms:

iSense

Intelligent Wireless
IOT System

inSync™

Full Spectrum
Human Centric Lighting

PoE

Power over
Ethernet

Technology Compatibility:



BLE

Bluetooth Low Energy

Direct / indirect light with Collimator lens



Electrical Data

Cat. No.	Variant	System wattage (W) +/- 10%	*Mains current (A)	Rated voltage (AC)	Approx. weight (Kg)	Case Lot (No.s)
LM96-451-060-57-DN	Indirect-direct Down 4ft 60°	25	0.11	240	4.4	2
LM96-451-60DA57-DN	Indirect-direct Down 4ft 60° Dali	25	0.11		4.4	
LM96-901-060-57-DN	Indirect-direct Down 8ft 60°	50	0.22		8.4	
LM96-901-60DA57-DN	Indirect-direct Down 8ft 60° Dali	50	0.22		8.4	
LM96-501-060-57-UD	Indirect Up Down 4ft 60°	30	0.13		4.6	
LM96-501-60DA57-UD	Indirect Up Down 4ft 60° Dali	30	0.13		4.6	
LM96-102-060-57-UD	Indirect Up Down 8ft 60°	60	0.26		8.6	
LM96-102-60DA57-UD	Indirect Up Down 8ft 60° Dali	60	0.26		8.6	

- "060" stands for Symmetric Collimator 60° Beam Angle
- "57" represents 5700K. Replace with "40" for 4000K CCT
- "DN" stands for Down Light, "UD" stands for Up-Down Light
- "DA" stands for product with Dali driver
- *Mains current will have tolerance as per is 16104: 2012
- Suspended codes to be ordered separately



Continuous installations with connectors



Product Specifications

- Extruded Aluminium housing and die casted endcaps duly powder coated in matt white
- Suitable for standalone and continuous row installations
- Driver is pre-wired up to terminal block. Integral driver for indirect and external driver box for direct/indirect with collimator
- Provision for loop in loop out for ease of wiring

Product Dimensions

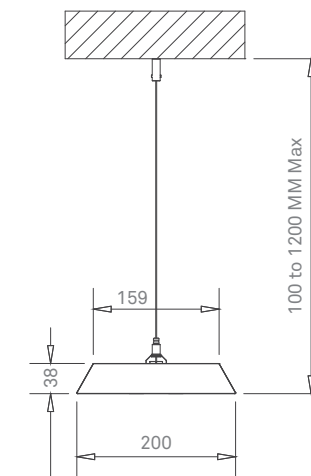

4ft Direct/Indirect with Collimator

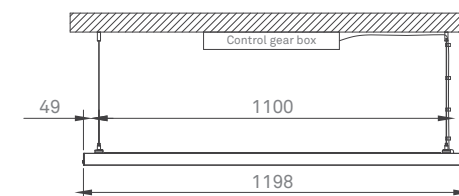

8ft Direct/Indirect with Collimator

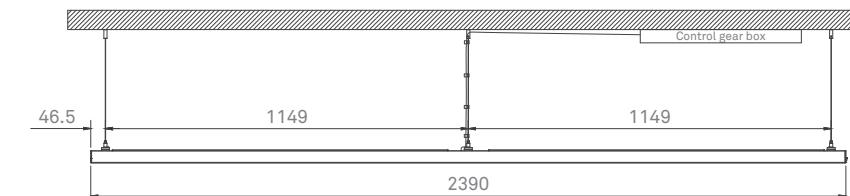

Installation: Desired suspension system to be ordered separately as indicated below

Product Length	Cat No.	Description	Suspension Qty. in one set	Suspension set required per luminaire
1200 mm	LMX961	1.5 mtr. Suspension suitable for installation on RCC ceiling	2	1
2400 mm	LMX962	1.5 mtr. Suspension suitable for installation on RCC ceiling	3	1

Direct / Indirect with Collimator



100%
Downlight



Downlight +
Up-light



60°
beam angle



UGR<19
for Down



UGR<16
for Up-Down



CRI 90



CCT
2700K - 6500K



IP20

Compatible Wipro Platforms

iSense
Intelligent Wireless
IOT System

inSync™
Full Spectrum
Human Centric Lighting

PoE
Power over
Ethernet

Technology Compatibility

BLE
Bluetooth
Low Energy

